

SI-L137-SOM-PBD2

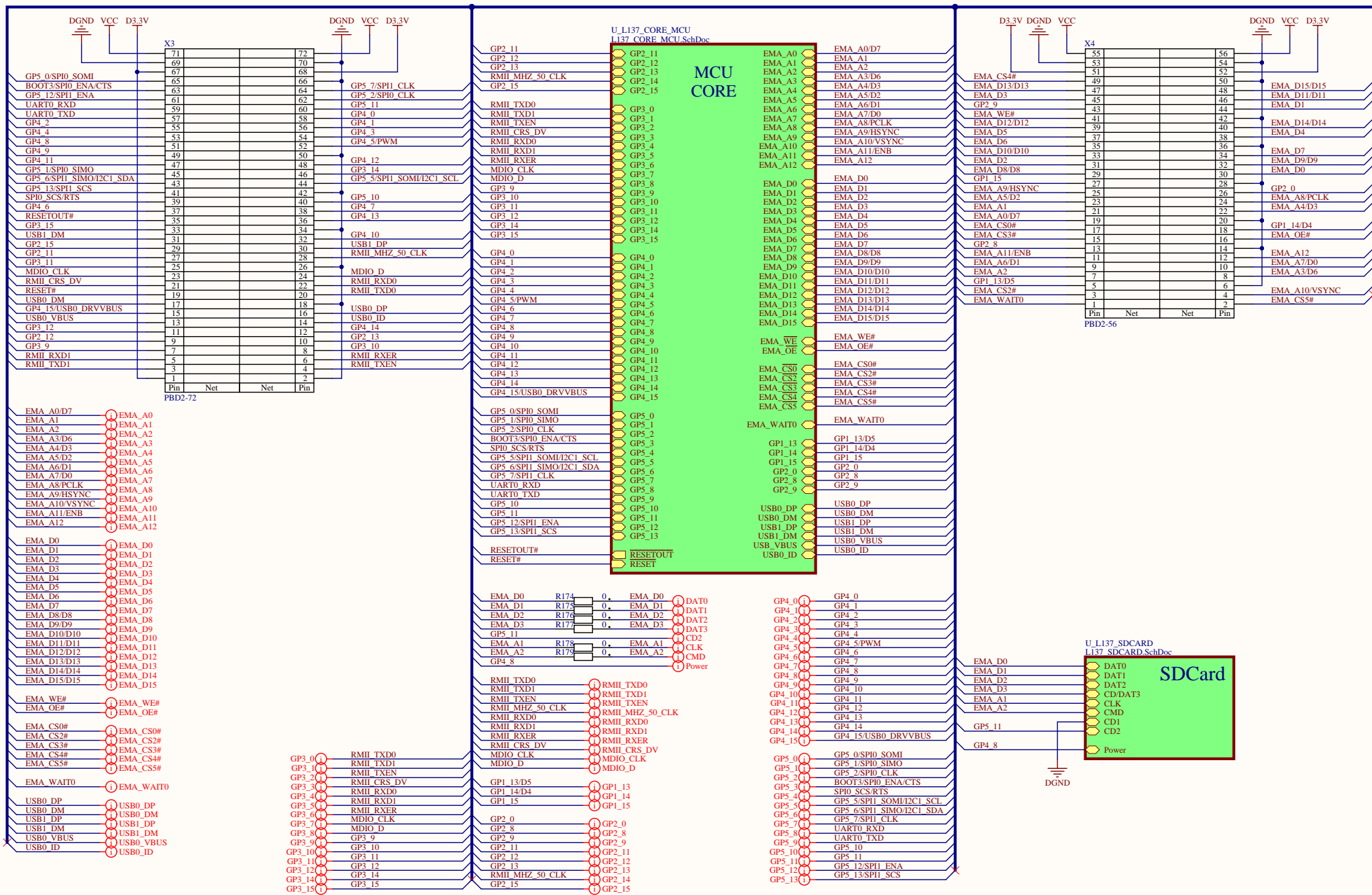

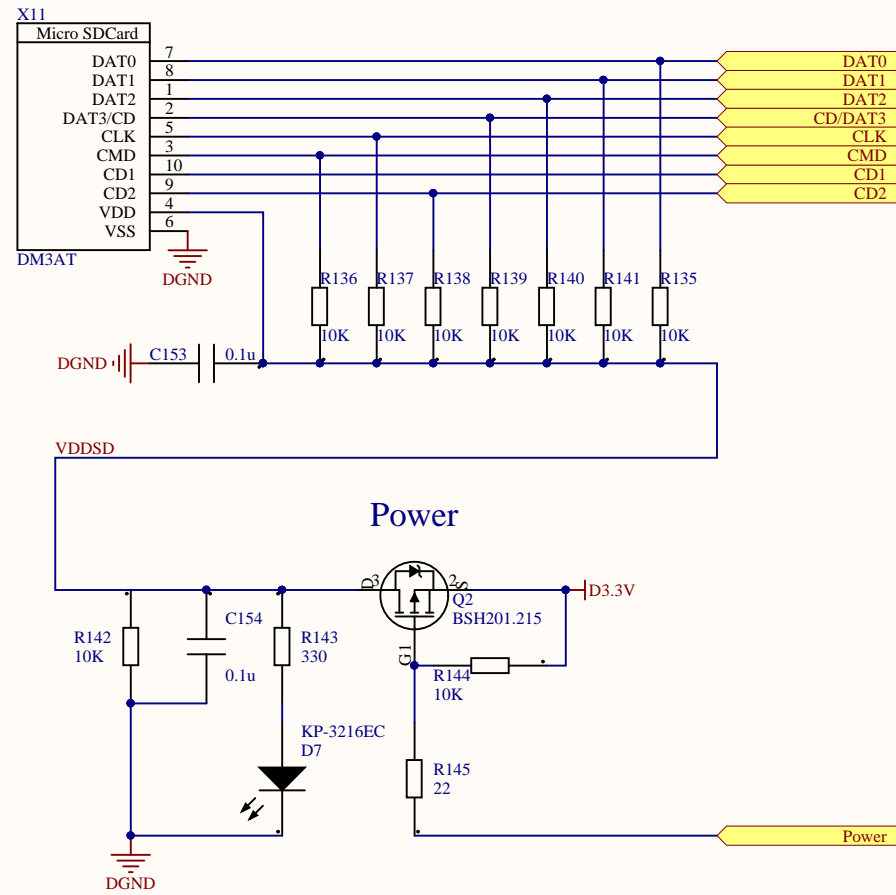





L137_SDCard



Power_Supply

Test Point

- D5.0V  TP1
- D1.26V  TP4
- D3.3V  TP5
- D1.2VOUT  TP6
- D1.8V  TP7
- DGND  TP8

